

### Warning and safety instructions

1. Only interior using for this type of luminaire.
2. Main voltage supply must be disconnected or switched off before installation, uninstall or cleaning.
3. Use the enclosed protective gloves when handling the reflector, if applicable.
4. Ensure there is enough space for heat dissipation of the luminaire, do not place anything in 10cm around the luminaire. The luminaire must not under any circumstance be covered with heat insulating materials.
5. The luminaire must not be installed on inflammable parts of building.
6. Keep object out of the required minimum distance along the optical axis of the light source.
7. Please refer to the specific installation instructions, the label or imprint on the luminaire for information concerning any restrictions relating to the use of luminaire, type of installation and etc.
8. If necessary the ceiling should be reinforced at the supporting points of the mounting frame or bracket.
9. The luminaire must only be operated with control gear matching the LED module provided or recommended by AKZU. No liability is accepted if used with other control gears.
10. When installing, always observe relative local rules and regulations.

### Limitations

Our warranty is contingent upon the observance of this product information, in particular, it shall be void if the fitting instructions are not followed, the fitting dimensions are not observed, or any modification is made to the luminaire.

### Cleaning

1. Luminaires should be cleaned regularly to make sure its working in good condition.
2. Disconnect the power and wait it is cooled down before cleaning.
3. Use soft cloths to clean.
4. Use litmusless detergent.
5. Do not use rigid, sharp, frictional or similar material or tool to clean
6. Do not use acidic, alkaline, ethanol or similar chemicals to clean.

1. 此类灯具只适用于室内。
2. 安装、拆卸或清洁灯具之前，请务必断开或关闭电源。
3. 如果有反射罩需要操作，请使用所附手套进行。
4. 确保灯具有足够的空间散热，不要在灯具周围10cm内放置任何物品。灯具不可安装在被隔热材料覆盖的环境下。
5. 灯具不可安装在建筑物的易燃部分上。
6. 确保被照物体在要求最小照射距离之外。
7. 请参考相关的安装说明，产品标签等资料上关于该灯具安装和使用等方面的限制说明。
8. 如果必要，请加固天花上用于支撑安装外框或支架的部分。
9. 请使用AKZU提供或推荐的与LED模组匹配的驱动电源控制器，使用其他驱动电源控制将不受保修条款保护。
10. LED模块不可更换。
11. 安装时，请务必遵守当地相关法律法规。

### 限制说明

保修服务只适于遵守产品使用规范的情况，如果不遵守安装指南，安装尺寸，或对灯具的任何改装，保修服务将失效。

### 清洁说明

1. 为保证灯具运行状态良好，请定期对其进行清洁维护。
2. 清洁灯具之前，请务必关断电源并等待灯体冷却。
3. 请使用软质布料进行操作。
4. 请使用中性清洁剂。
5. 请勿使用硬质、尖利、摩擦性大或类似的材料或工具清洁。
6. 请勿使用酸性、碱性、酒精性或类似化学物质清洁。

All data, images, and specifications are for reference only and may be changed due to product improvement without prior notice.

More details at  
[www.akzu.com](http://www.akzu.com)

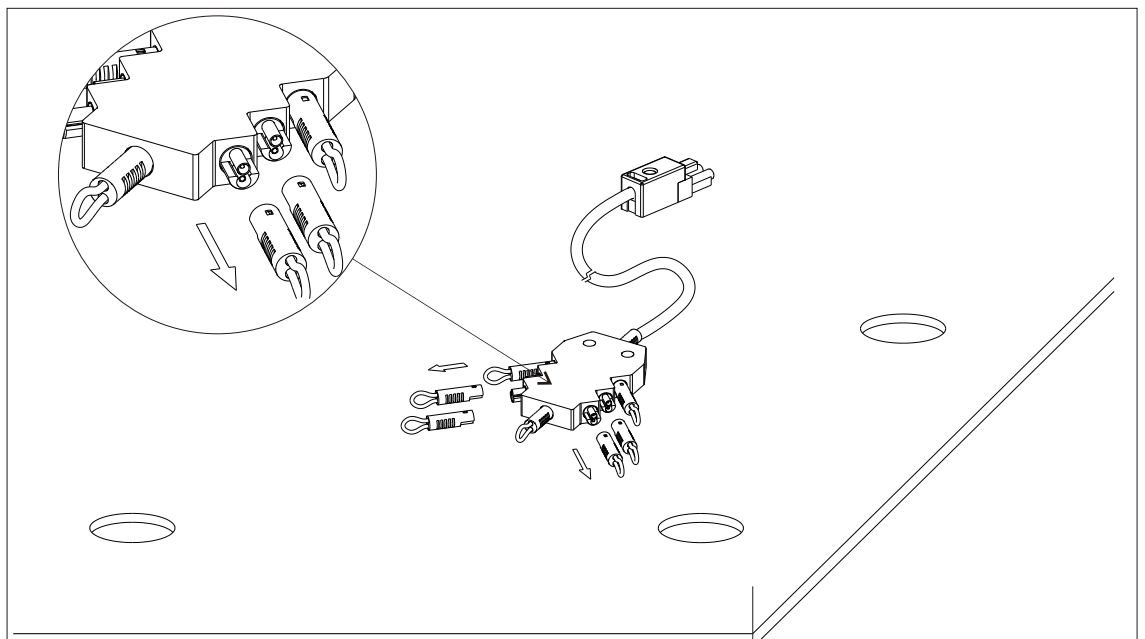
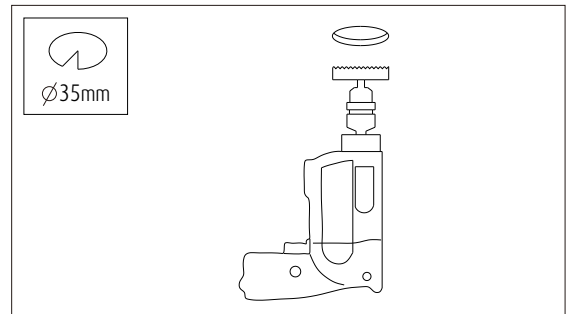
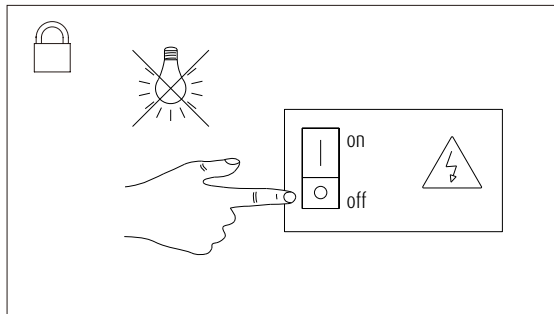
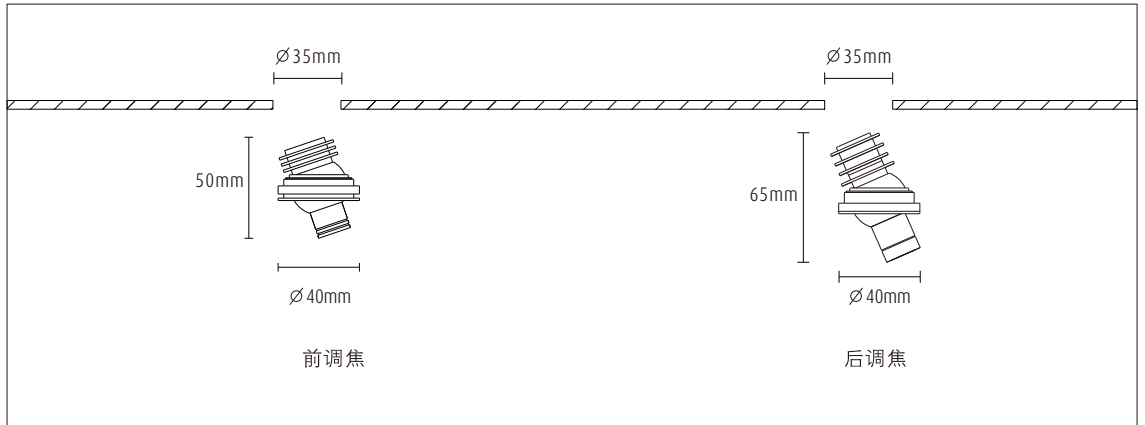
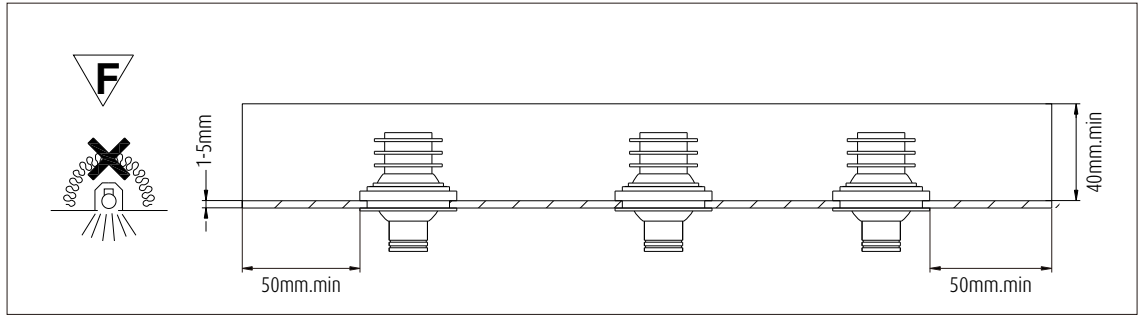

All data, images, and specifications are for reference only and may be changed due to product improvement without prior notice.

More details at [www.akzu.com](http://www.akzu.com)

Do not unplug the short circuit terminal of the unused port, otherwise the current can not form a loop and the light can not be turned on.

不用到的端口不要拔掉短路端子，否则电流无法构成回路，灯具不会亮。

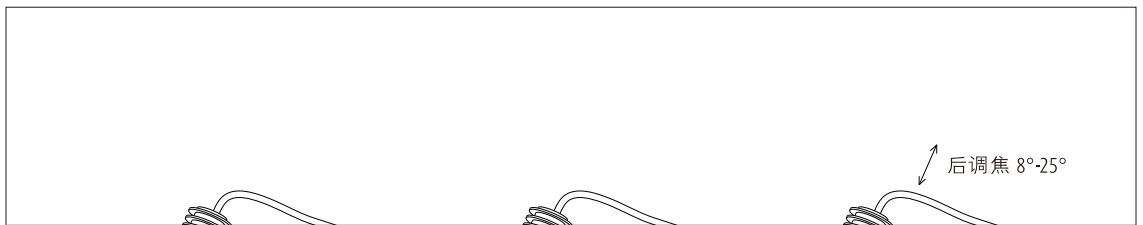
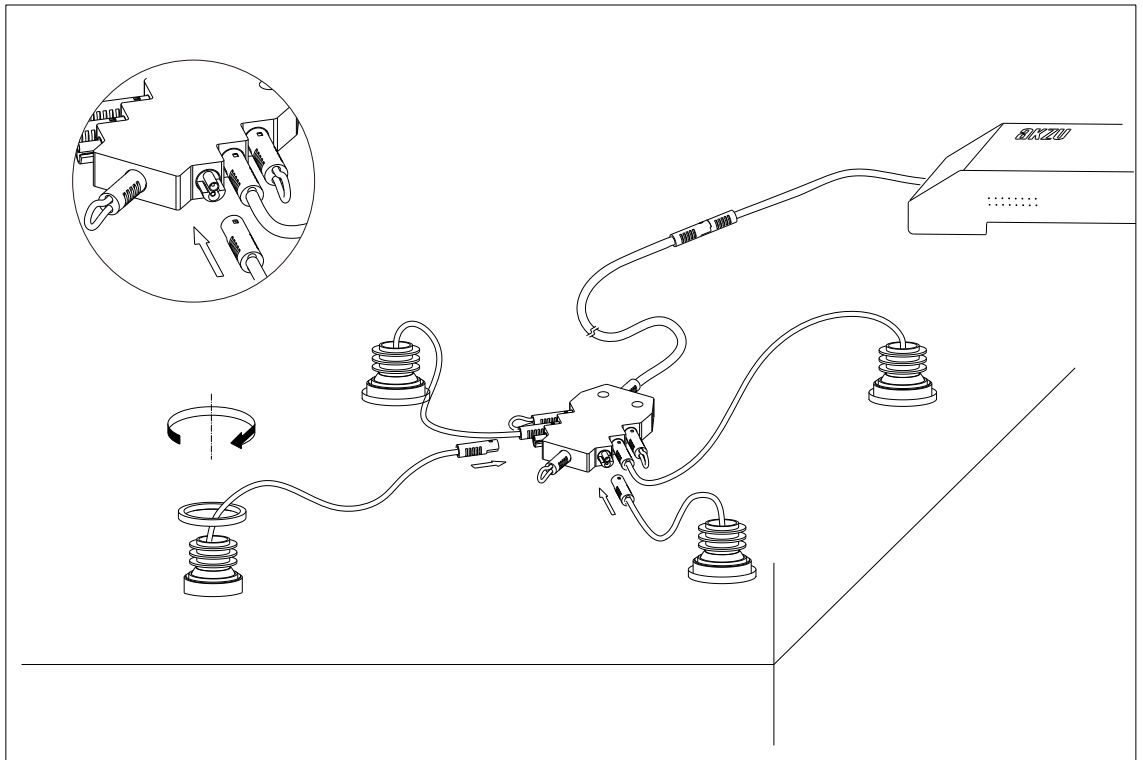
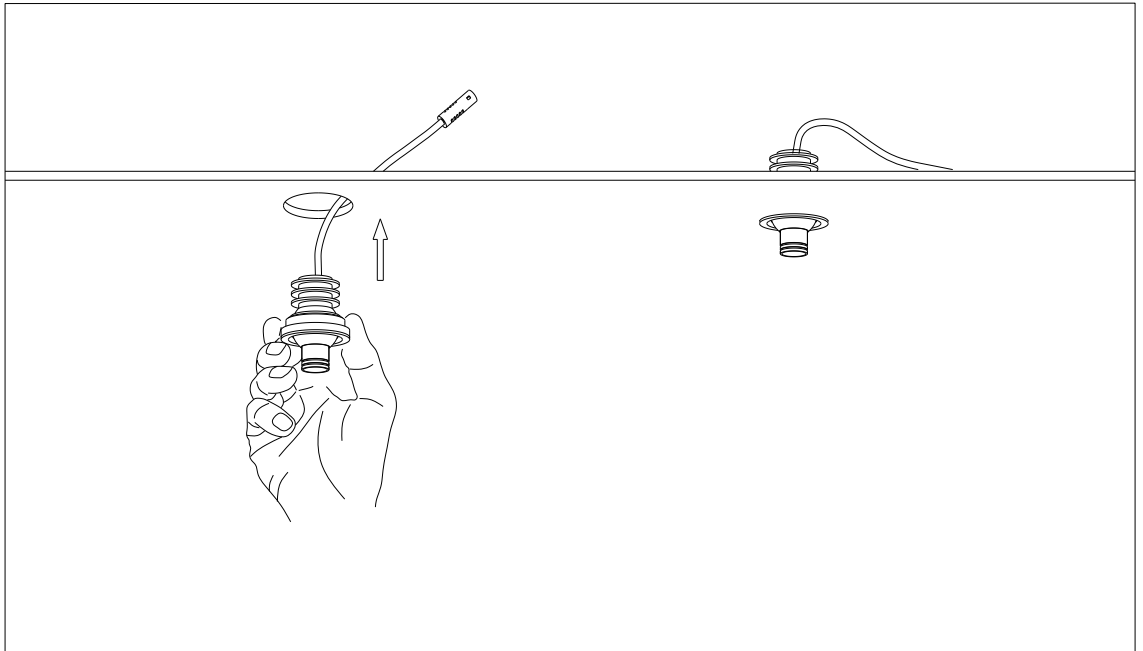

All data, images, and specifications are for reference only and may be changed due to product improvement without prior notice.

More details at [www.akzu.com](http://www.akzu.com)

# akzu Installation instruction

for Sprite X1 series recessed mounting

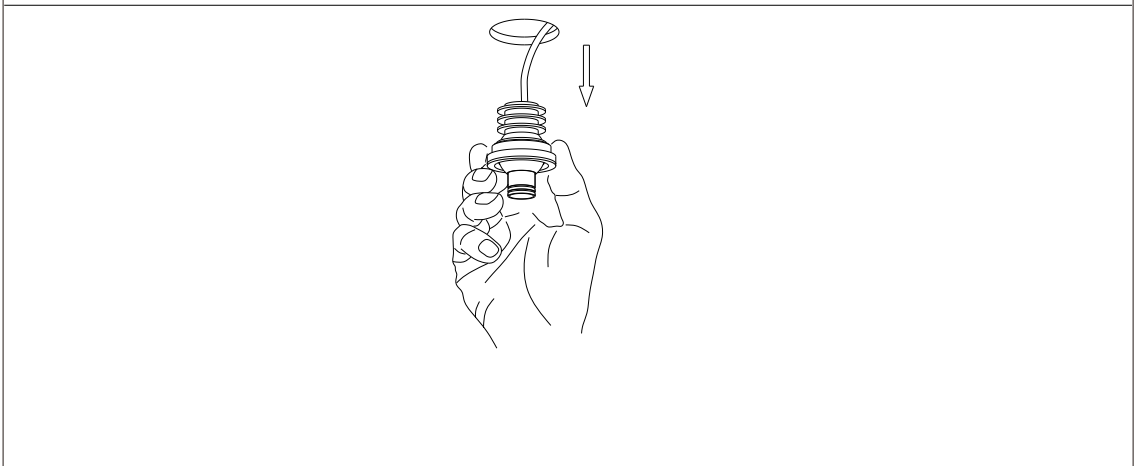
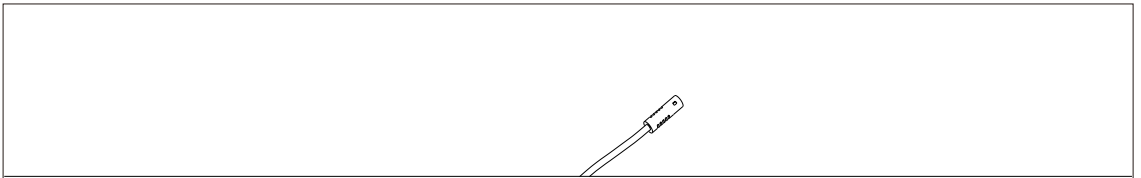
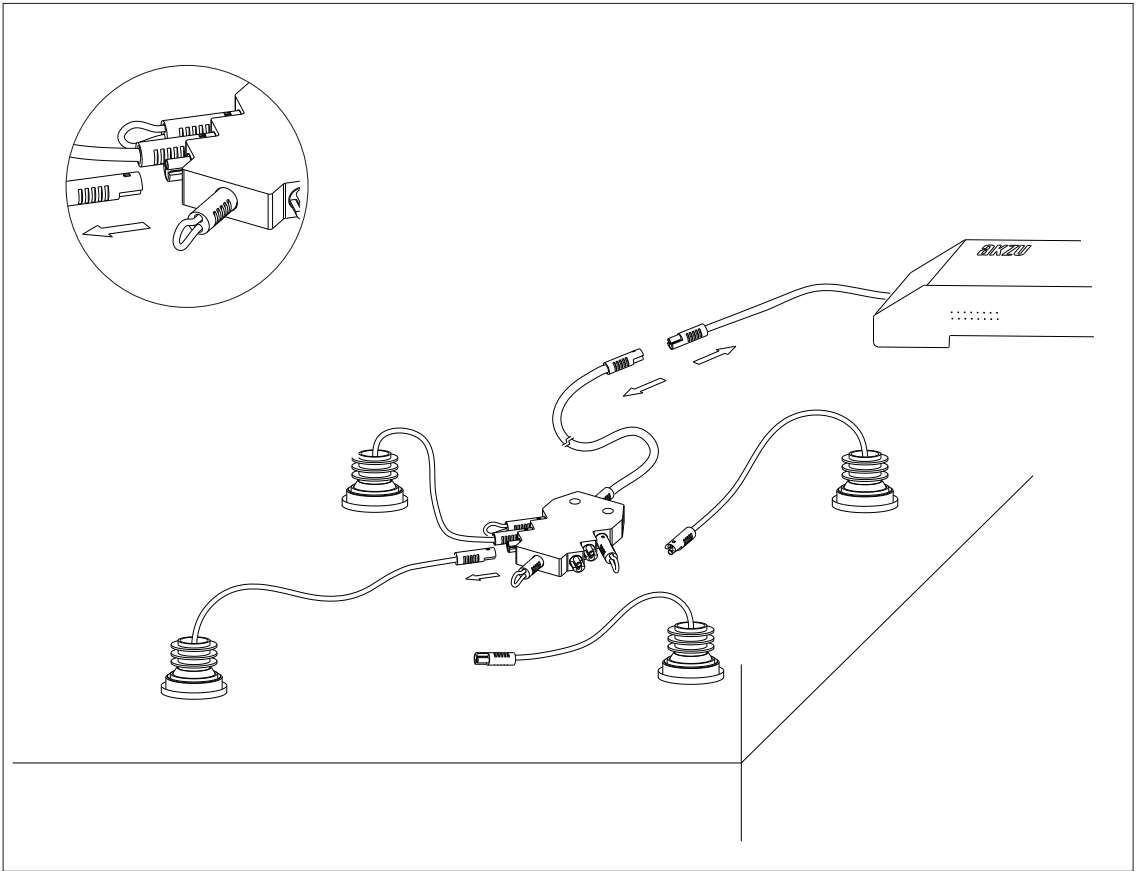
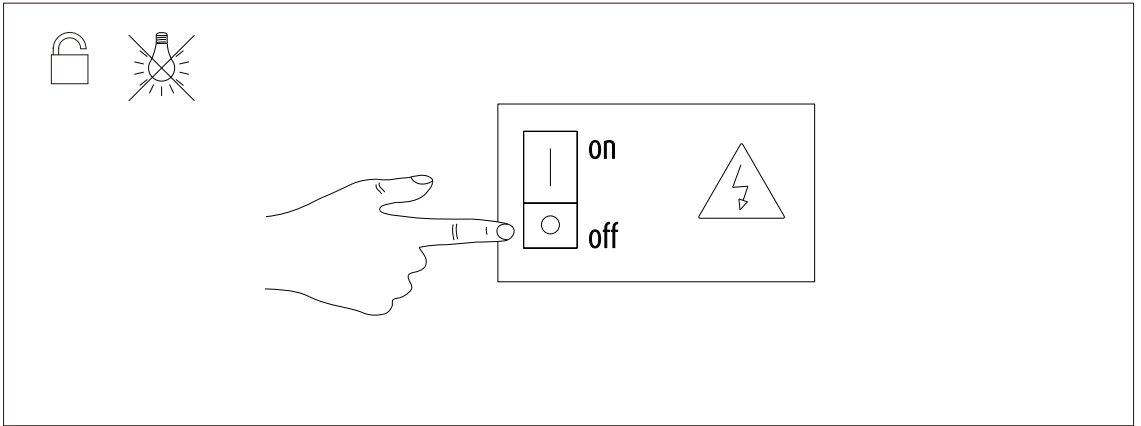

All data, images, and specifications are for reference only and may be changed due to product improvement without prior notice.

More details at [www.akzu.com](http://www.akzu.com)

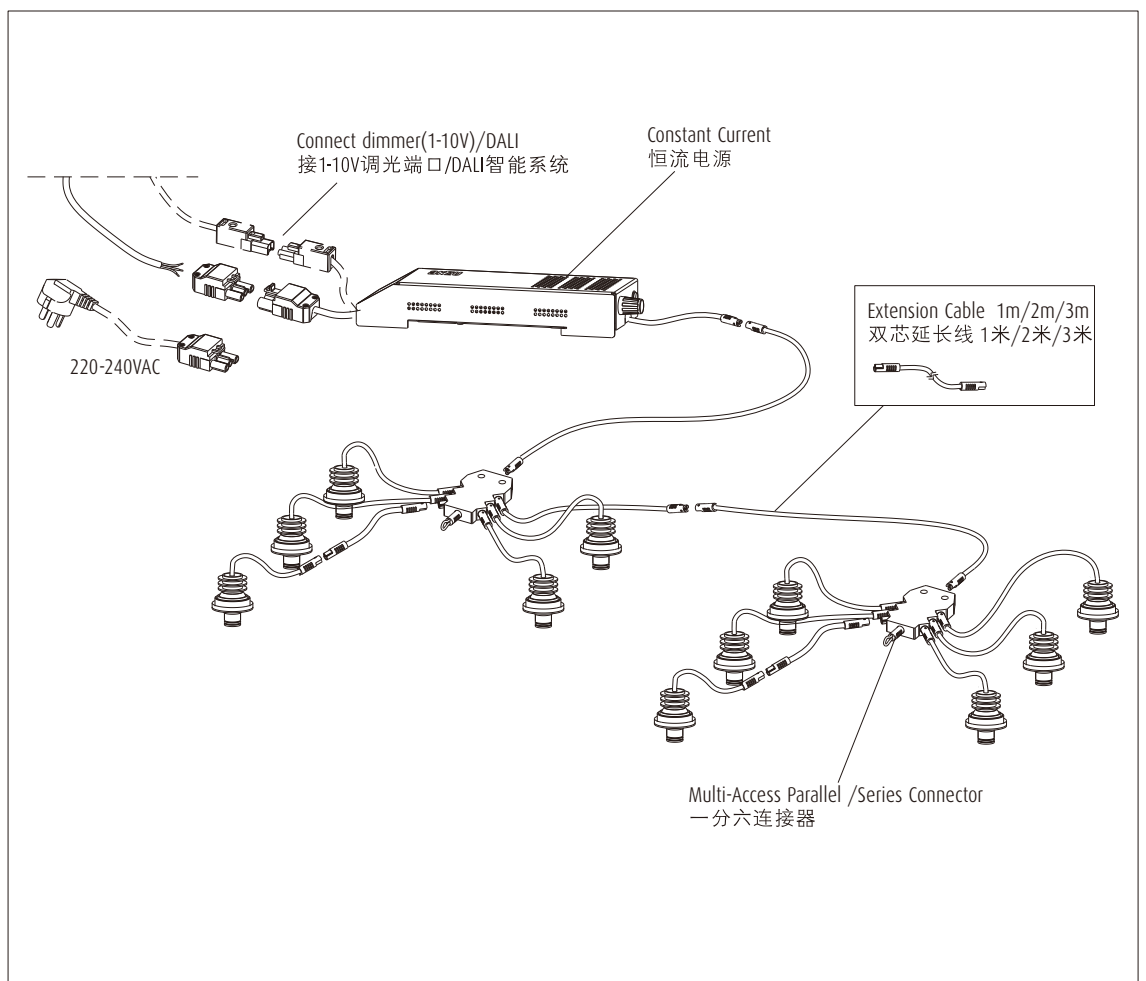
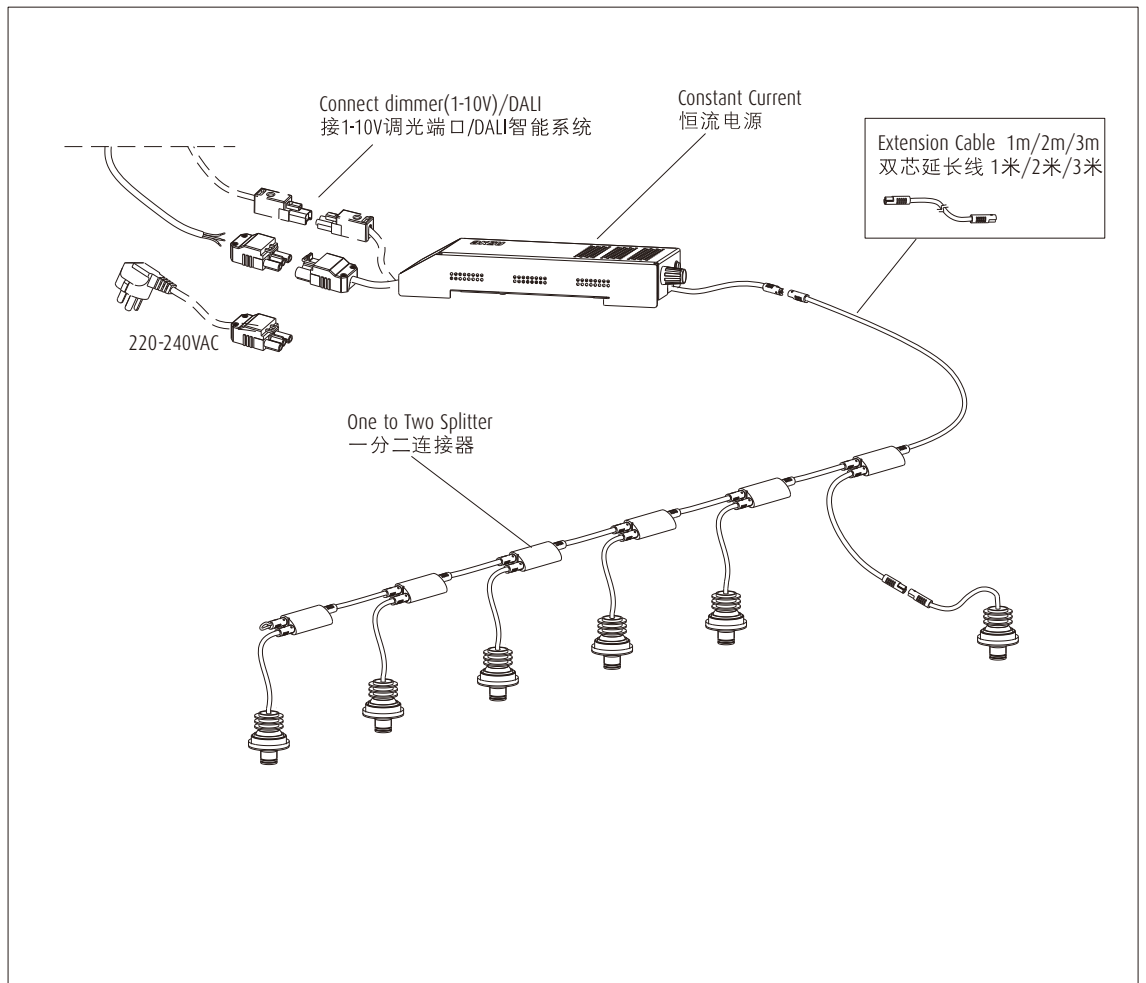

All data, images, and specifications are for reference only and may be changed due to product improvement without prior notice.

More details at [www.akzu.com](http://www.akzu.com)

# AKZU Installation instruction

## for Sprite X1 series recessed mounting

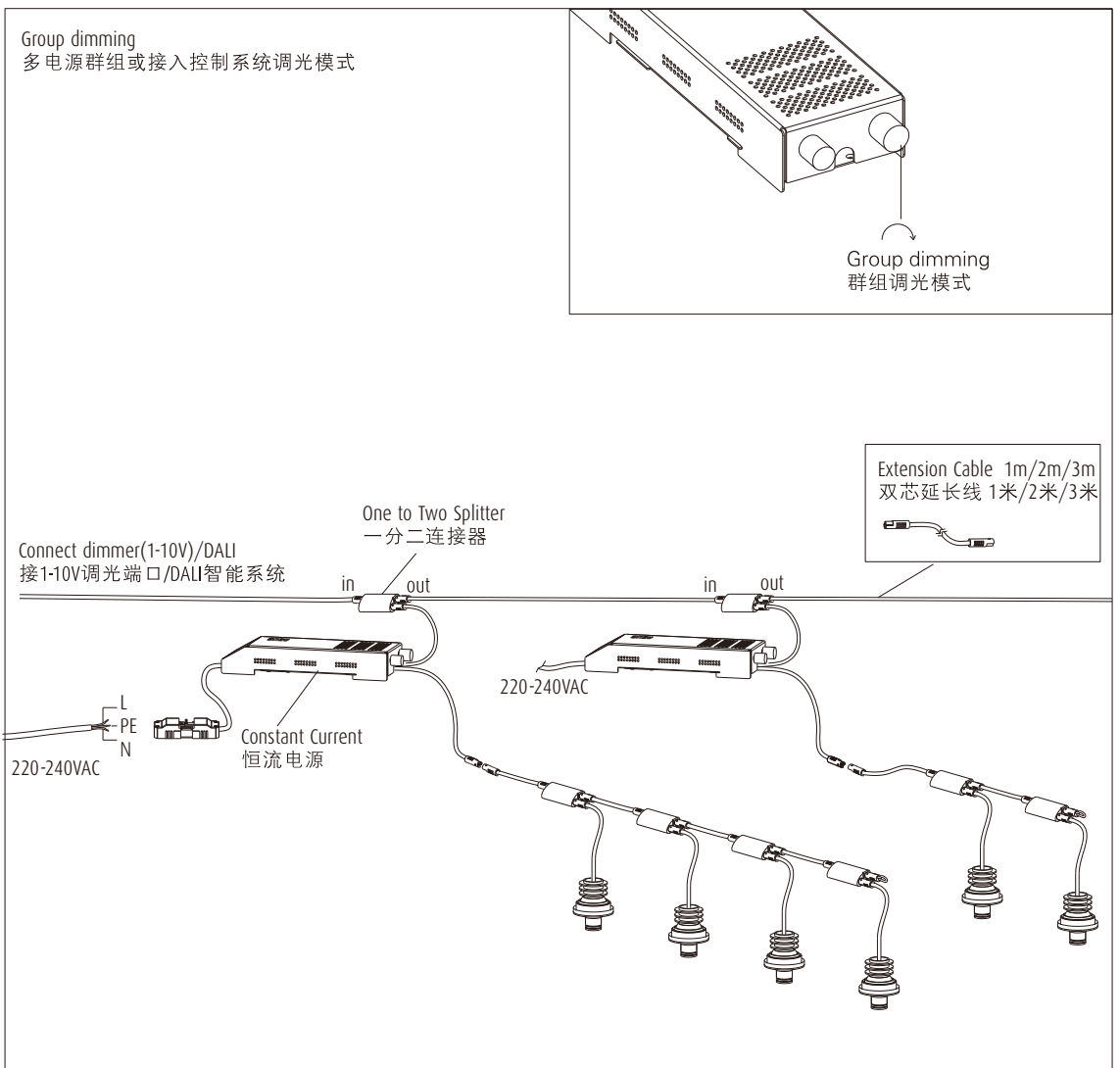
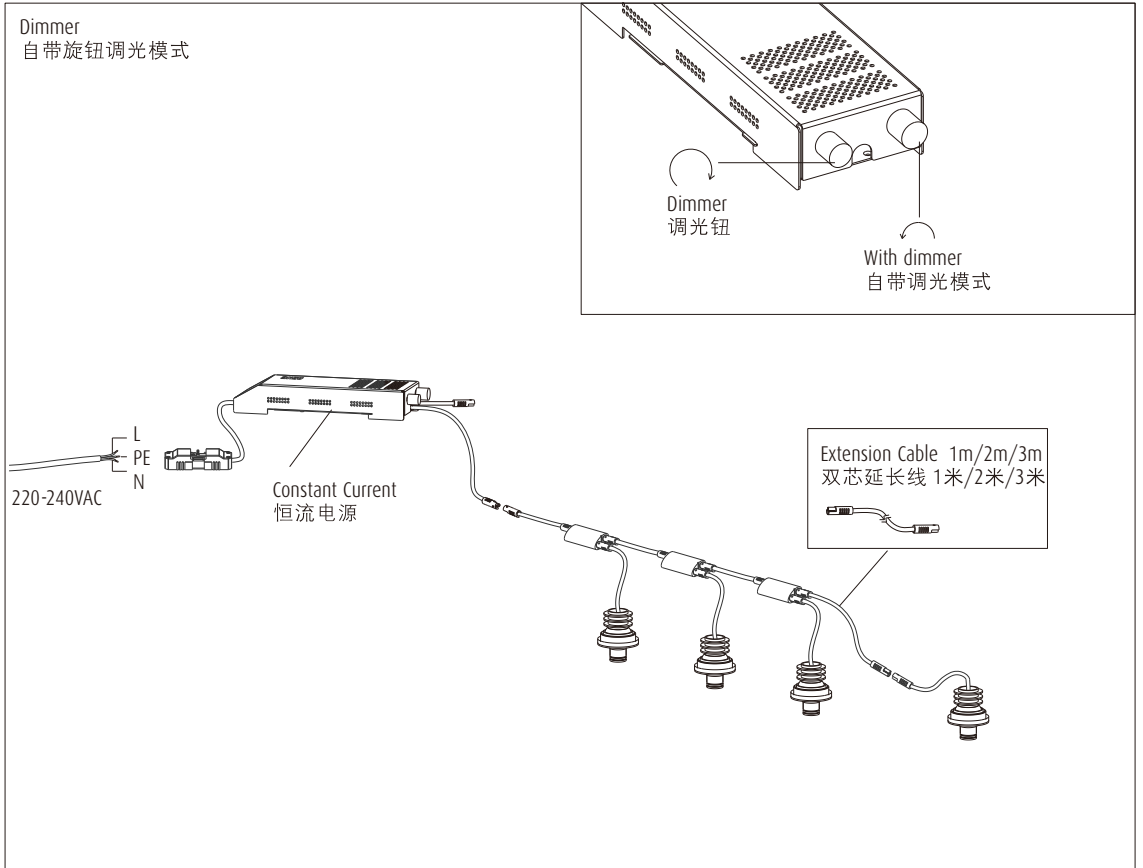

All data, images, and specifications are for reference only and may be changed due to product improvement without prior notice.

More details at [www.akzu.com](http://www.akzu.com)